

Specifications: (typical)

Power Supply Voltage:	12 VDC
IR Frequency range supported:	30 kHz - 56 kHz
Maximum number of targets:	16
Maximum distance to emitters:	500 ft.

Specifications subject to change without notice.

CHANNEL VISION Limited Warranty

Channel Vision Technology will repair or replace any defect in material or workmanship which occurs during normal use of this product with new or rebuilt parts, free of charge in the USA, for two years from the date of original purchase. This is a no hassle warranty with no mail in warranty card needed. This warranty does not cover damages in shipment, failures caused by other products not supplied by Channel Vision Technology, or failures due to accident, misuse, abuse, or alteration of the equipment. This warranty is extended only to the original purchaser, and a purchase receipt, invoice, or other proof of original purchase date will be required before warranty repairs are provided.

Mail in service can be obtained during the warranty period by calling (800) 840-0288 toll free. A Return Authorization number must be obtained in advance and can be marked on the outside of the shipping carton.

This warranty gives you specific legal rights and you may have other rights (which vary from state to state). If a problem with this product develops during or after the warranty period, please contact Channel Vision Technology, your dealer or any factory-authorized service center.

500-073 rev E

CHANNEL VISION™

P-1205 IR distribution hub

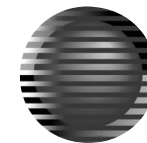
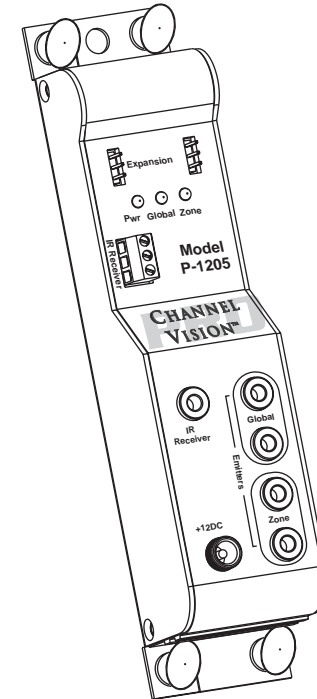

CHANNEL VISION™

234 Fischer Avenue • Costa Mesa, CA 92626
(714) 424-6500 • (800) 840-0288 • (714) 424-6510 fax
www.channelvision.com • email: sales @ channelvision.com

The **P-1205** distribution hub supplies power to any standard IR receiver and IR signals to 4 emitter outputs (2 global, and 2 zone specific).

- Multiple IR zones can be created with additional units
- Single power supply can support up to 16 IR receivers
- Both mini plug and 3-wire connection for receivers

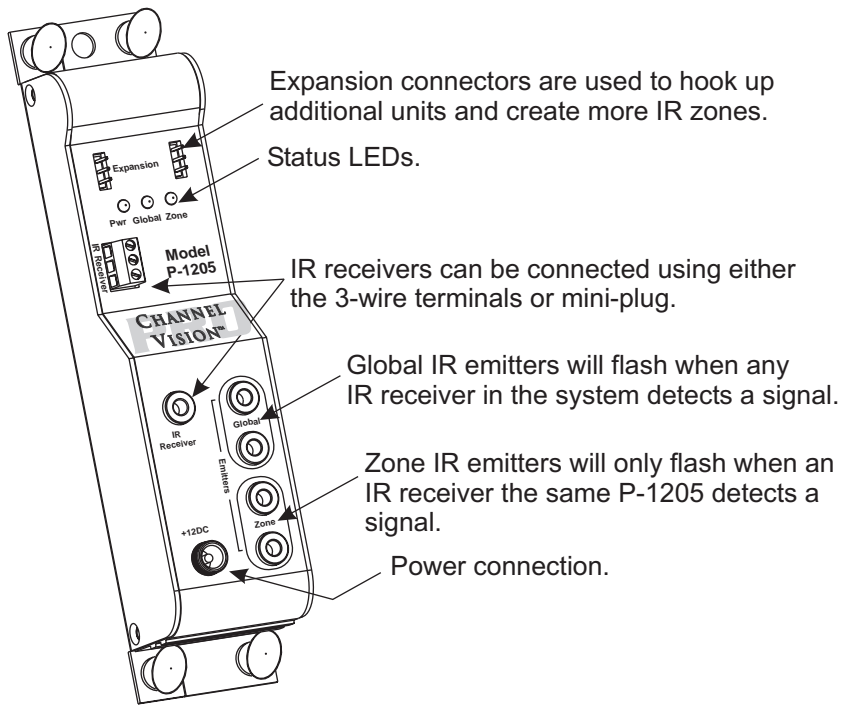

IR repeating concepts:

Most people are familiar with Infra-Red remote controls because they use them to operate their TV and other devices on a daily basis. However, some people may not be familiar with IR repeating. IR repeating allows the user to control devices which are not within the direct line of sight of the remote control. This is most commonly used in distributed audio/video systems where the source components are centrally located. See *How IR repeating works* on the next page for details.

IR zones:

Some IR systems, including the P-1205, are capable of creating zones that only repeat the IR signals that are picked up by a particular receiver (or group of receivers). This is useful when there are multiple devices from the same manufacturer, such as satellite decoders, that are operated with the same remote control. IR zones prevent one user from inadvertently control a satellite decoder that someone else is trying to watch.

Mounting Options

The *NEW P-1300* from Channel Vision's Pro-series product line is the perfect home for the P-1205. The P-1300 is a hinged plate designed to fit into a standard 19" rack.

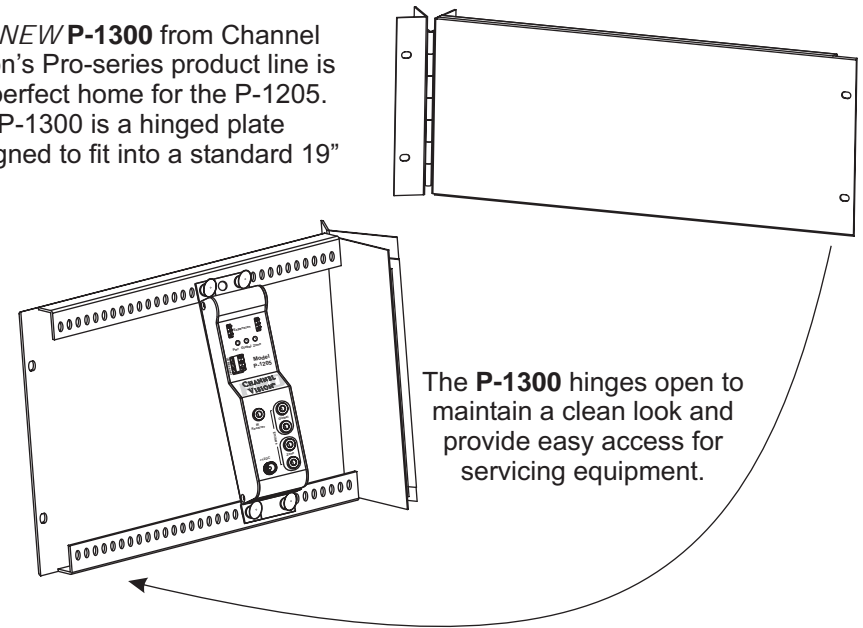

The P-1205 can also be mounted in a standard structured wiring enclosure as shown below.

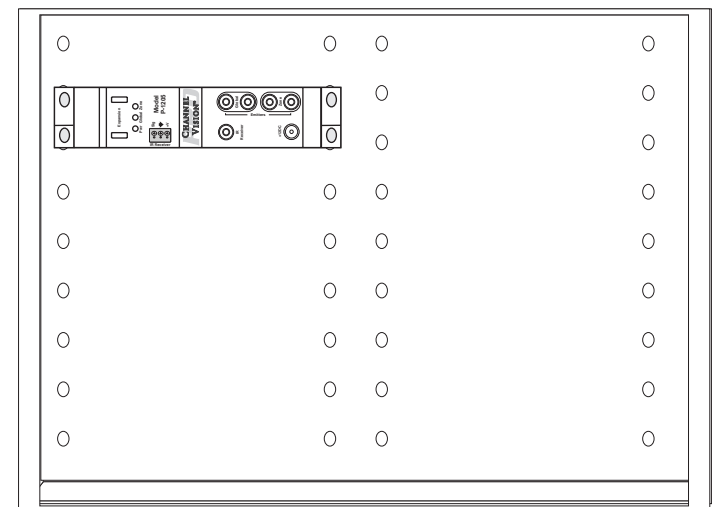

Zoned IR Setup

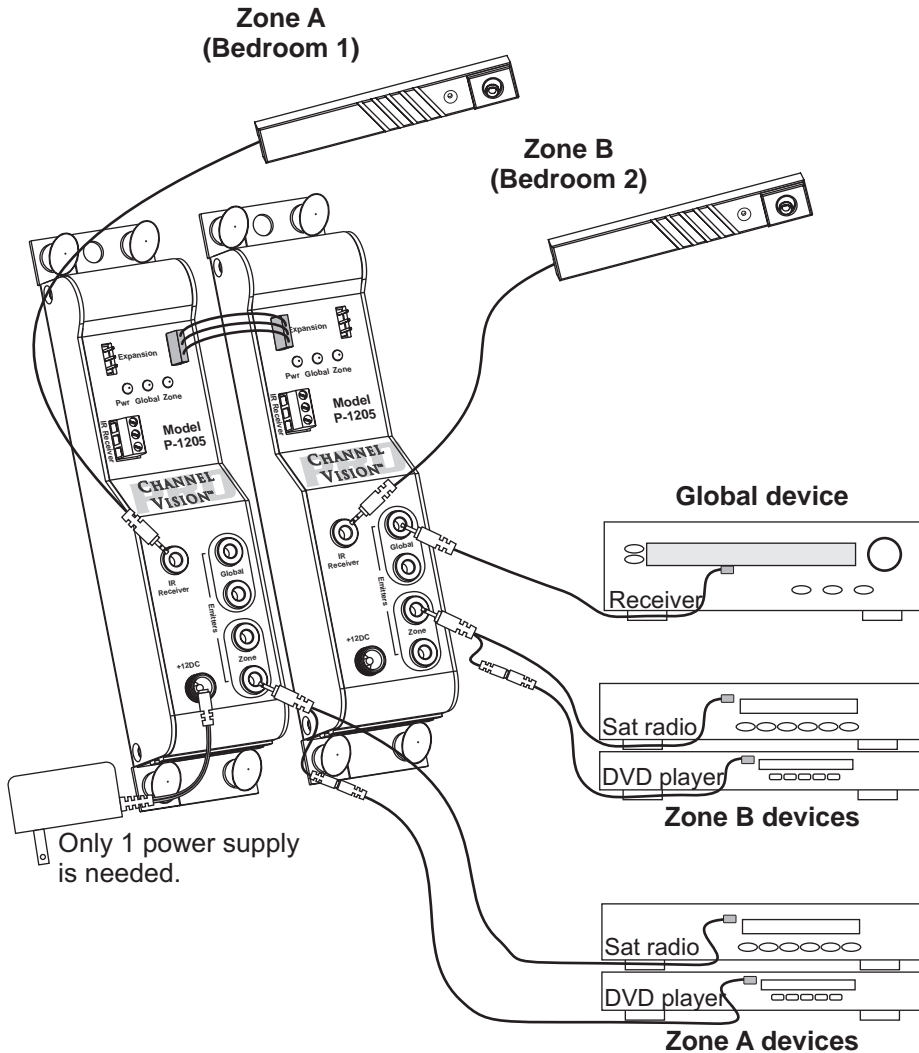

The diagram shown above, will create 2 IR zones that will allow for independent control of identical devices from the same manufacturer. The zone IR emitters will only respond to signals from the IR receiver that is in the same zone. The global IR emitters will respond to signals from any IR receiver in the system.

Other IR components

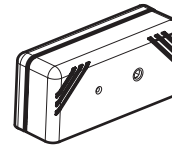

IR-2301 ... Table top IR Receiver. Can be placed on any flat surface such as a TV or entertainment center.

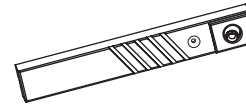

IR-2105 ... Stick type IR receiver with variable field of view. An adjustable blinder swivels around the IR pickup to prevent interference from light sources that may cause erroneous IR signals.

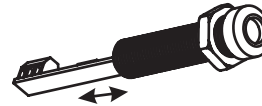

IR-2202 ... Tube type IR receiver with variable field of view. The IR pickup slides in and out of the tube to adjust the field of view.

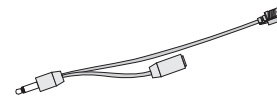

IR-3003... Single head IR emitter with expansion jack. As many as 3 units can be chained together and connected to a single emitter output.

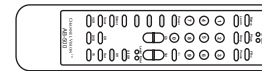

AB500 ... Universal remote control. Learns IR codes for up to 6 sources.

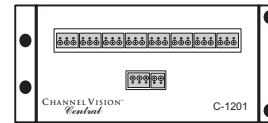

C-1201 ... IR receiver connecting block. Allows 8 IR receivers to be connected in parallel so that one set of wires can be connected to the P-1205

How IR repeating works

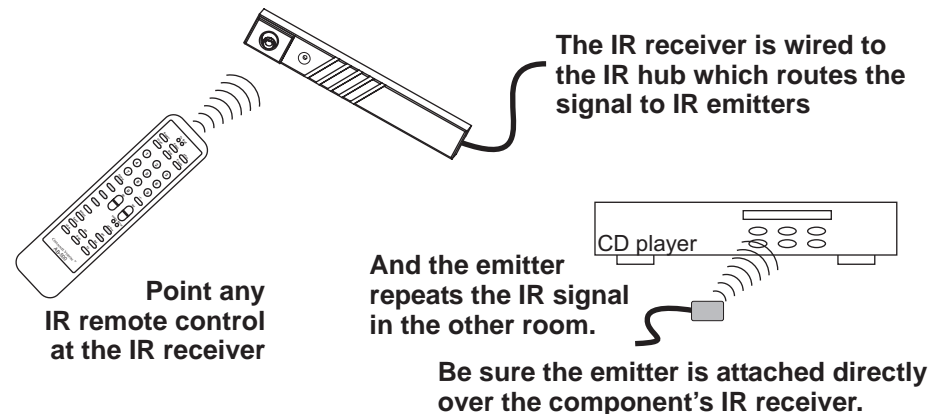

Basic IR Setup

A basic IR system, like the one shown below, is often used when audio/video devices are stored inside a closed cabinet and are out of the line of sight. The IR receiver is placed outside the cabinet so that the remote control can be pointed directly at it. It will detect the IR signals and route them to the P-1205, which in turn sends them to the emitter outputs.

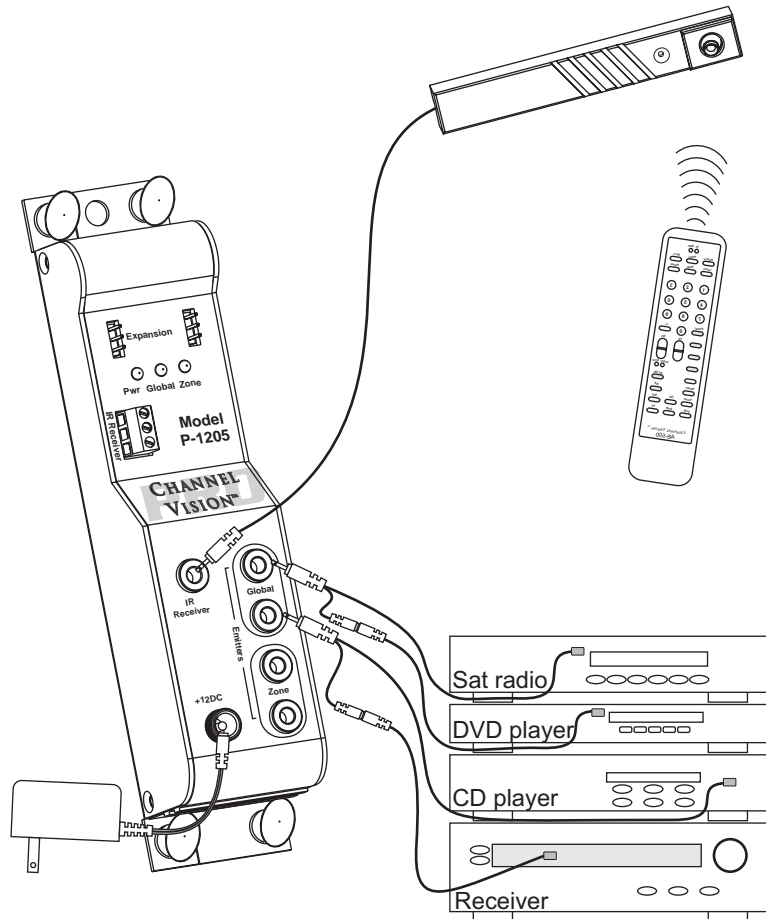

Whole-House IR Setup

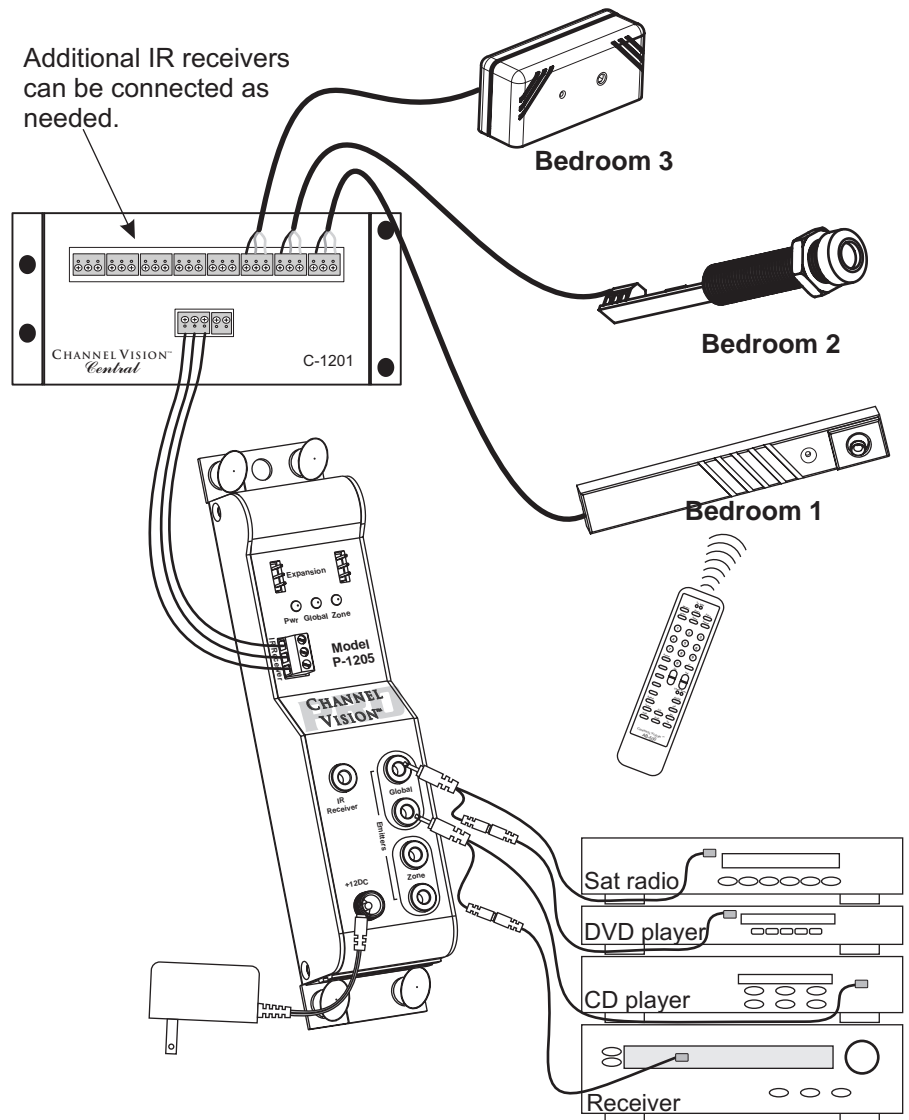

The diagram above illustrates how to create an IR system with IR receivers in several different rooms in the house. Systems like this may include several different styles of IR receivers depending on the specific application in each room.